

Ø10mm
50 G-90 1F

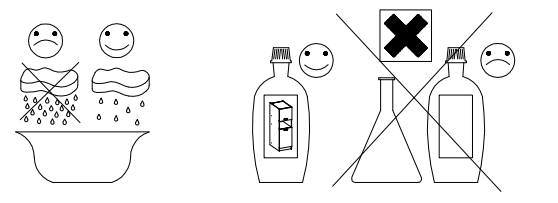

KUH.30001
KUH.40001

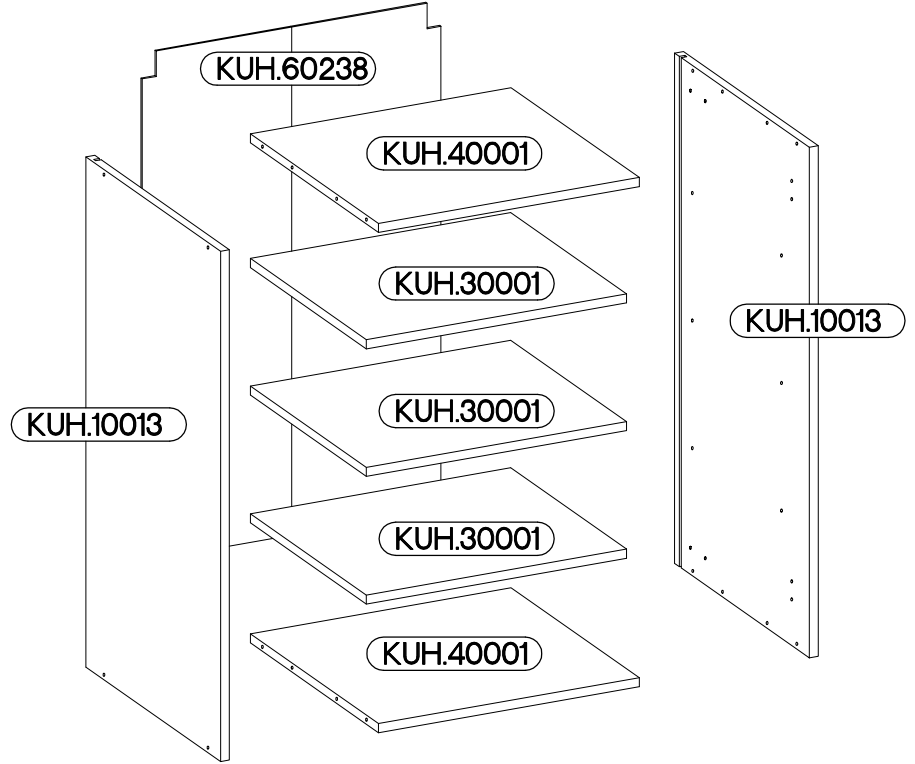

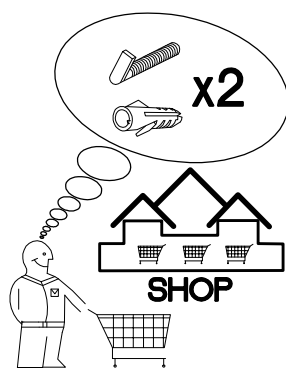
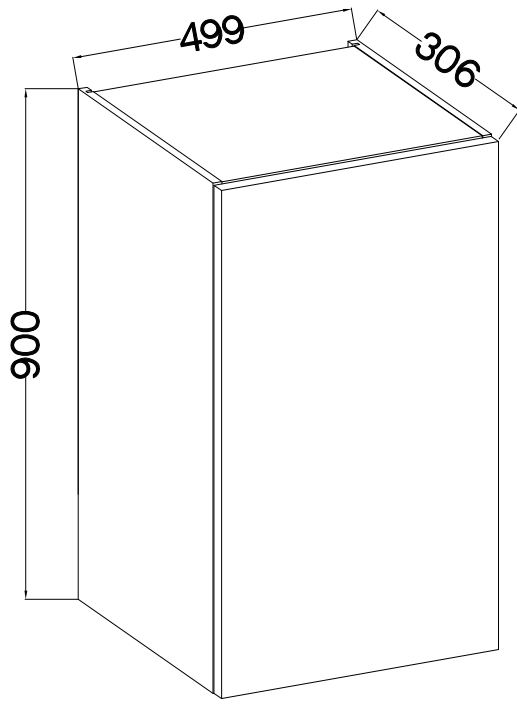
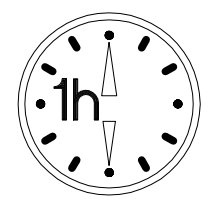

Ersatzteil Nummer	Dimension
KUH.10013 x2	900x290x16
KUH.30001 x3	466x250x16
KUH.40001 x2	467x276x16
KUH.60238	896x485x2,5

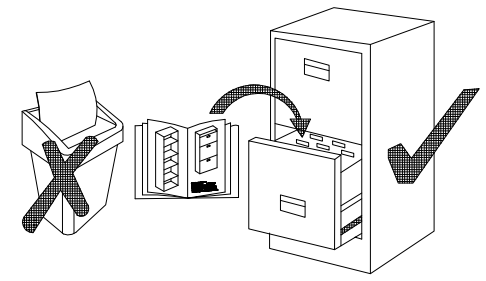
A	B	E1	HG		
8	8	8	2		
J	K	O	P5	P7	P8
12	2	1	4	8-10	4



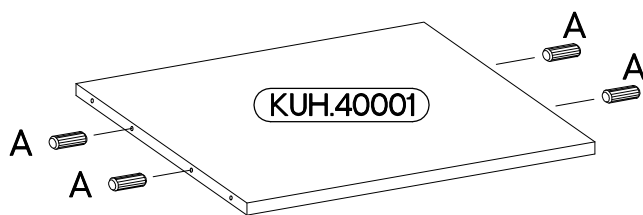
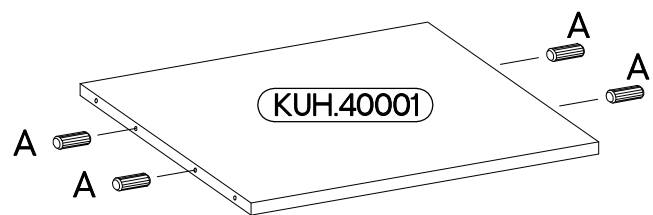
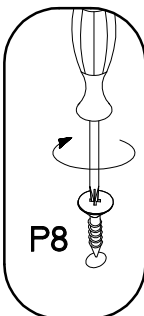
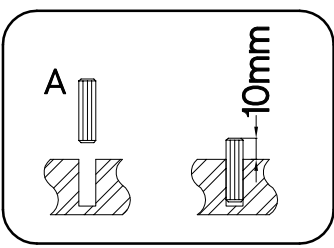
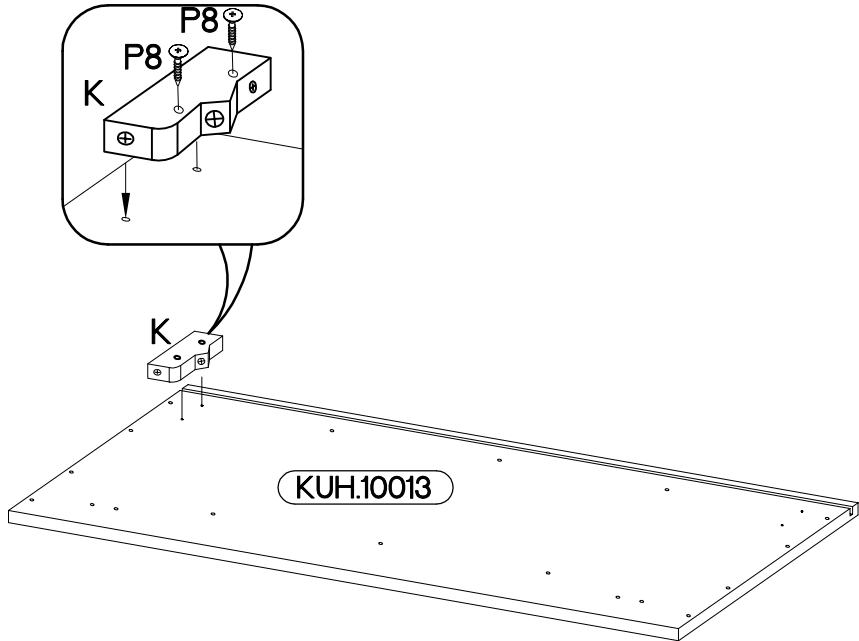
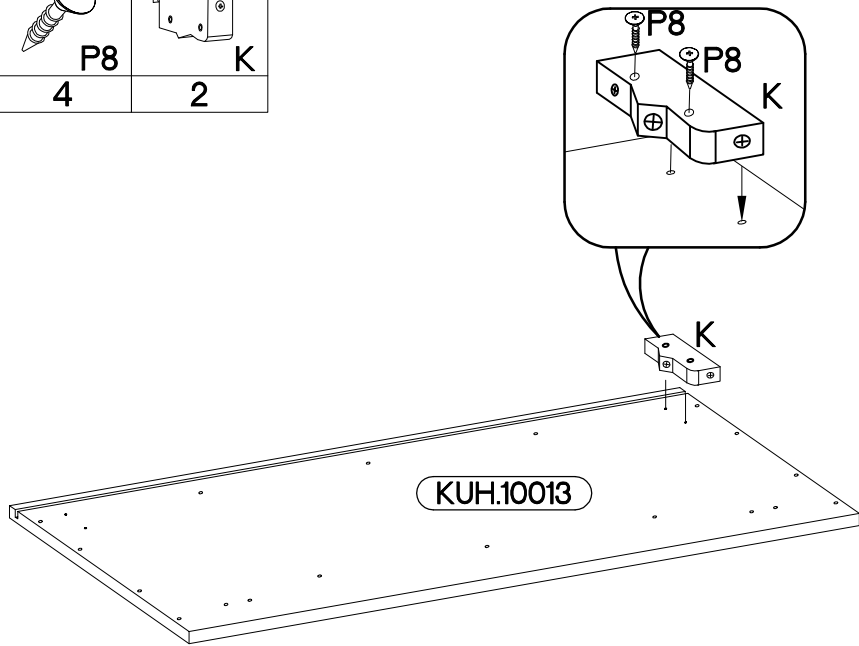
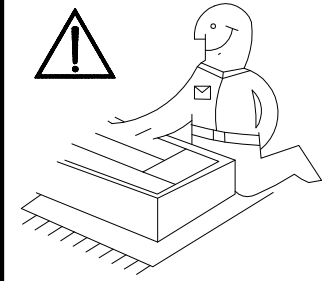

ISM-KUH-01125

 +8x30mm A	 +4.0x30mm P8	 K
8	4	2



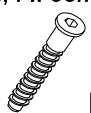
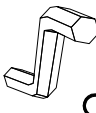

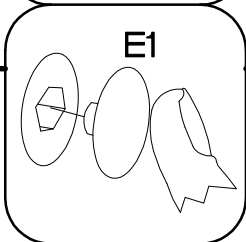
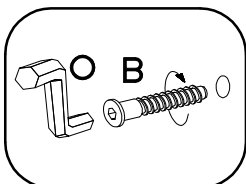
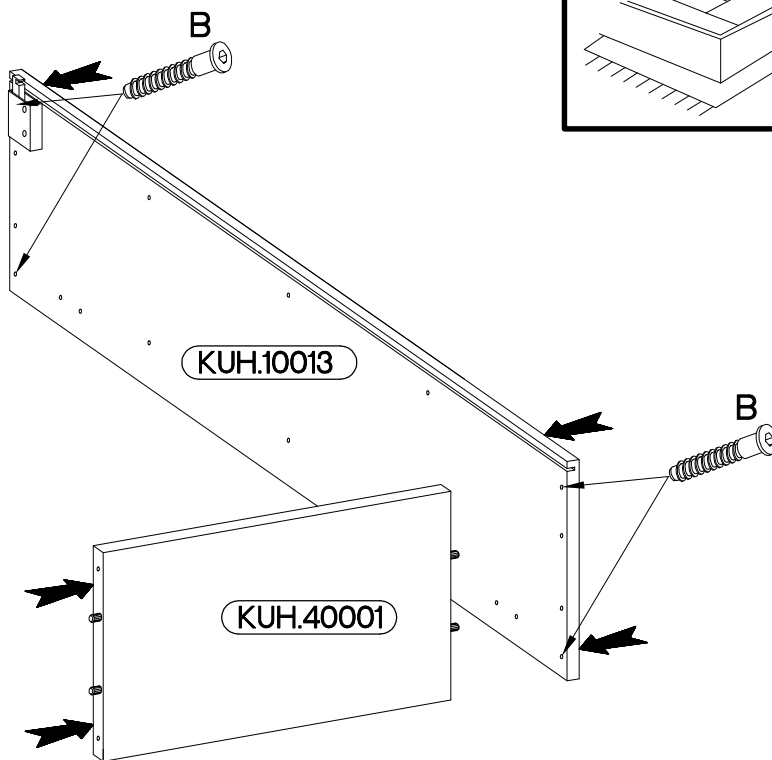
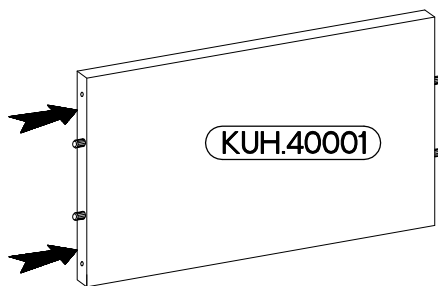
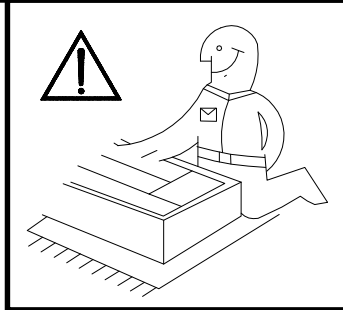

2

6,4 x 50mm		
		
B	O	E1
4	1	4

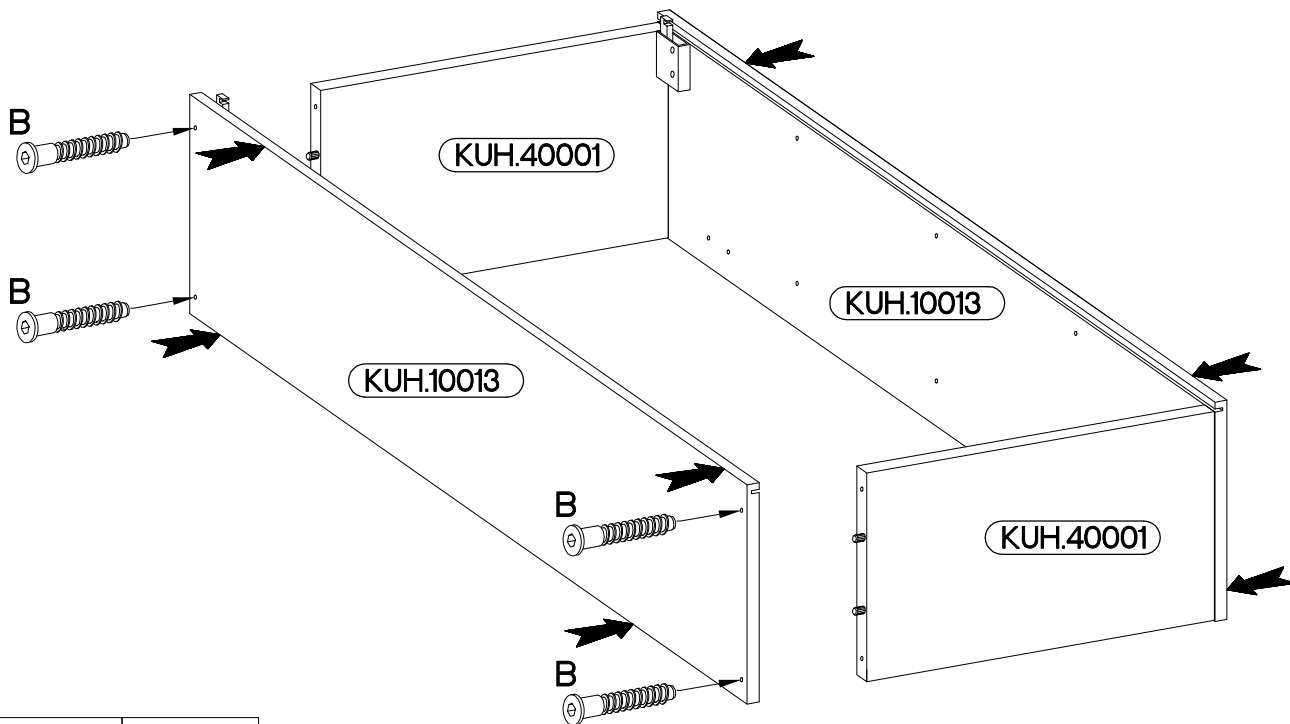

3

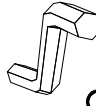

6,4 x 50mm		
		
B	O	E1
4	1	4

4

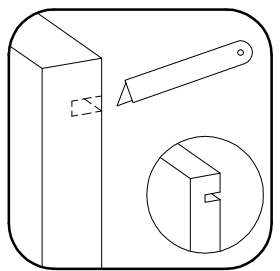
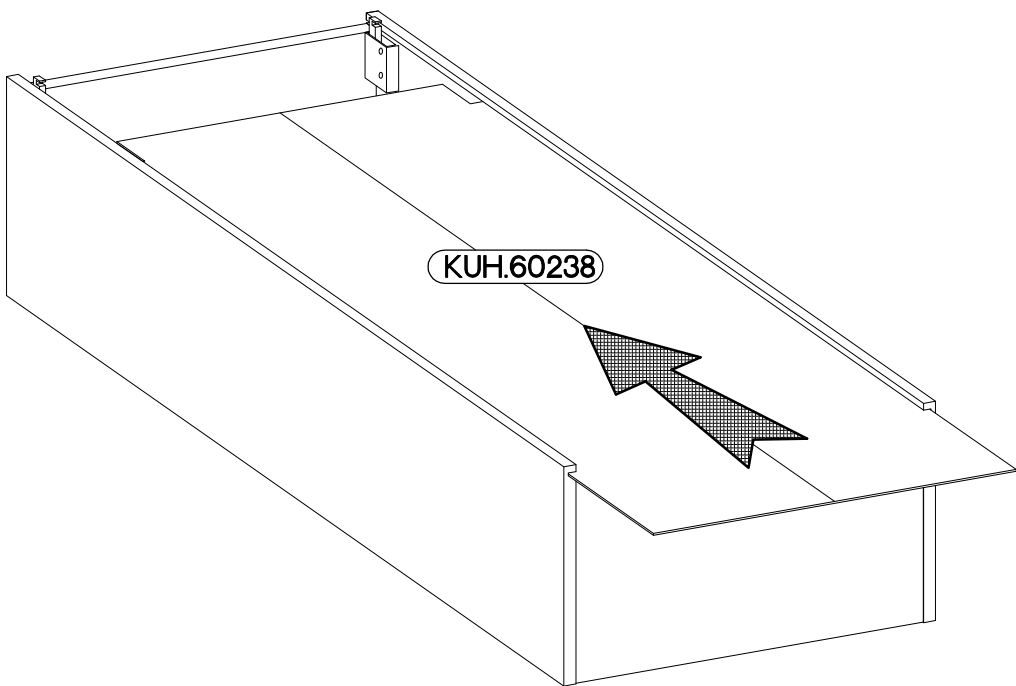
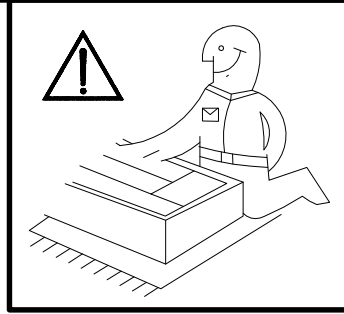

5

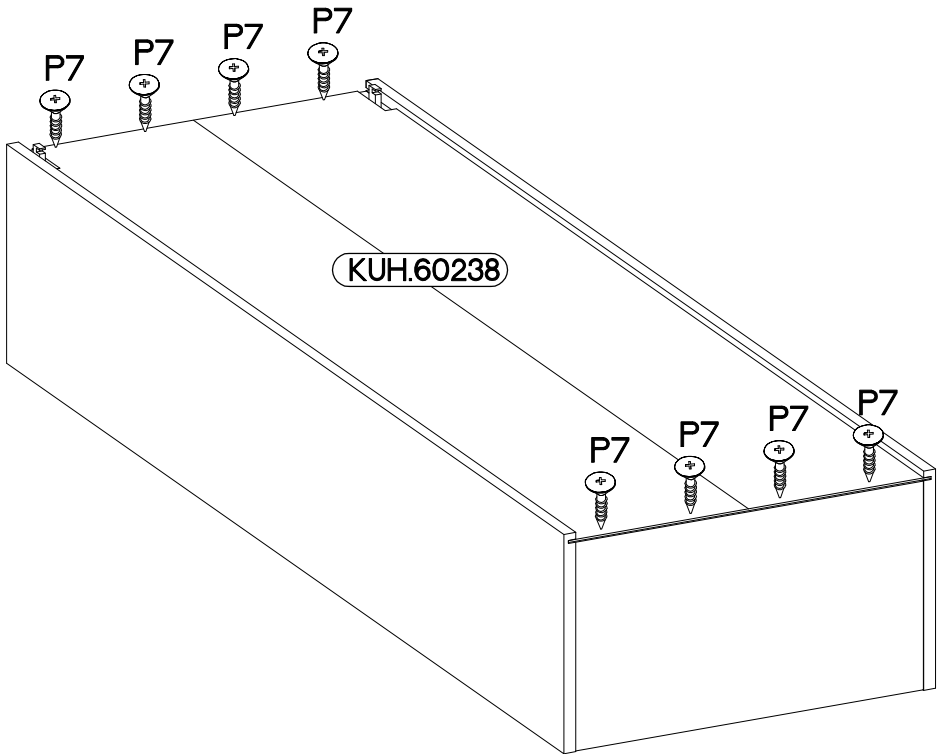
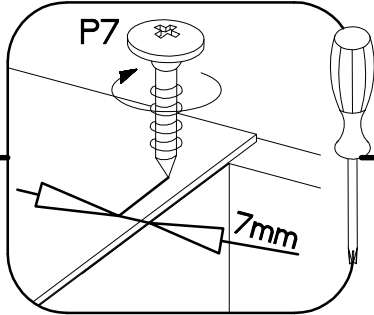
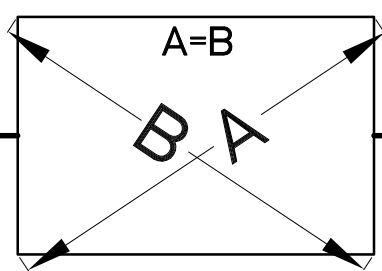
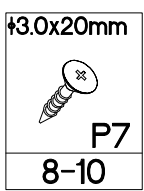

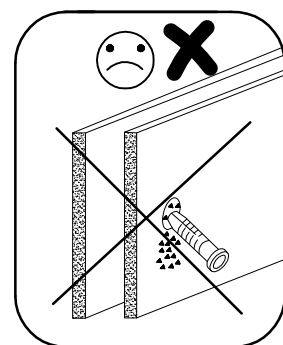
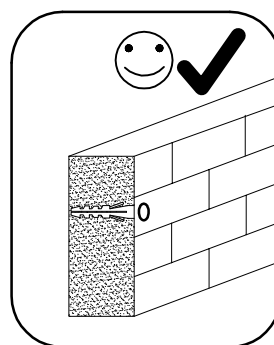
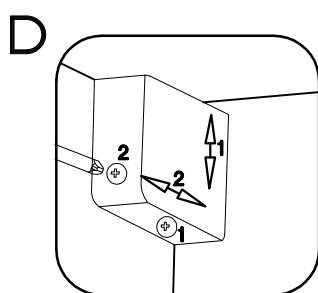
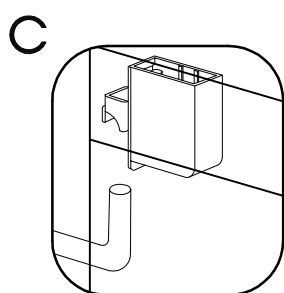
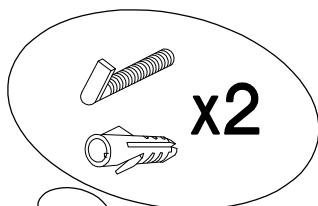
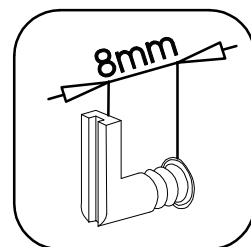
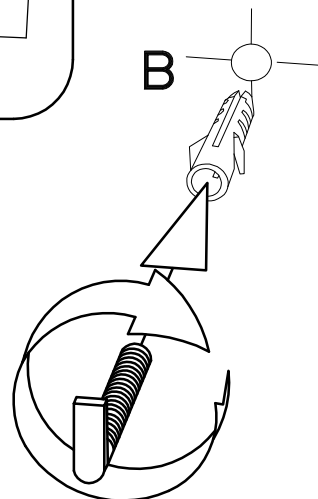
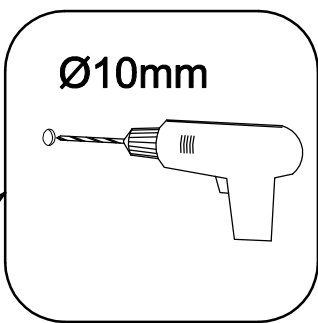
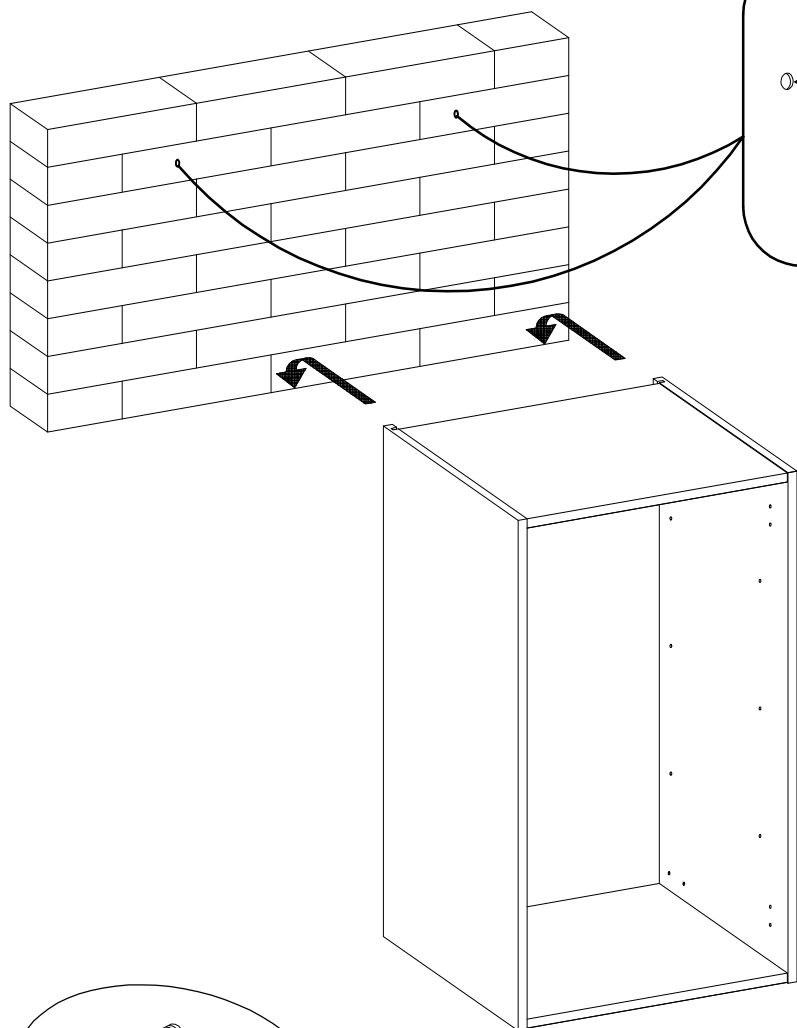
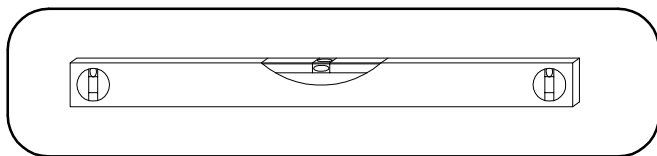

7

±5/19mm
J
12

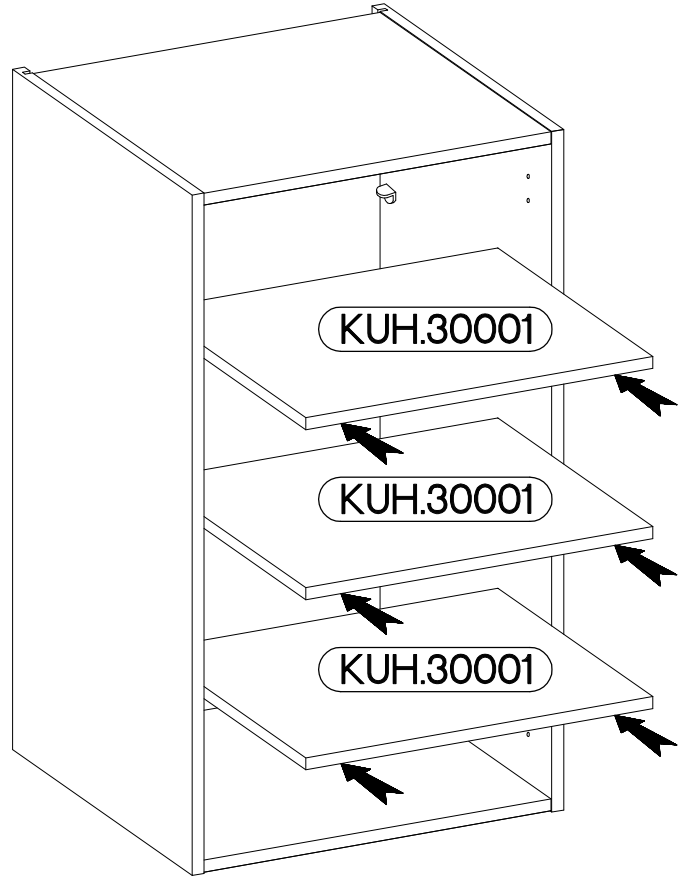
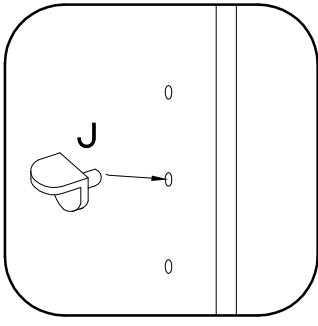

8

FRONT

